

ZS SQUARE II

Two Post Inground Lift

Original Operating Instructions

BA322301-en

ZS SQUARE II 3.5 FT
ZS SQUARE II 3.5 KS
ZS SQUARE II 3.5 M
ZS SQUARE II 3.5 P
ZS SQUARE II 3.5 PF
ZS SQUARE II 3.5 S
ZS SQUARE II 3.5 SG
ZS SQUARE II 3.5 SP
ZS SQUARE II 3.5 SPG

ZS SQUARE II 4.0 KS
ZS SQUARE II 5.0 KS
ZS SQUARE II 5.0 P
ZS SQUARE II 5.0 PF
ZS SQUARE II 5.5 KS
ZS SQUARE II 6.5 KS

BA322301-en
2019-07-10

© MAHA Maschinenbau Haldenwang GmbH & Co. KG

The reproduction, distribution and utilization of this document as well as the communication of its contents to others without explicit authorization is prohibited. Offenders will be held liable for the payment of damages. All rights reserved in the event of the grant of a patent, utility model or design. The contents of this edition have been checked with great care. However, errors cannot be fully excluded. Subject to technical change without notice.

Manufacturer

MAHA Maschinenbau Haldenwang GmbH & Co. KG
Hoyen 20
87490 Haldenwang
Germany

Phone: +49 8374 585 0
Fax: +49 8374 585 590
Mail: maha@maha.de
Web: www.maha.de

Service

MAHA SERVICE CENTER
Maybachstraße 8
87437 Kempten
Germany

Phone: +49 8374 585 100
Fax: +49 8374 585 491
Mail: service@maha.de
Web: www.mahaservicecenter.de

Contents

1	Safety	5
1.1	Introduction.....	5
1.2	Symbols and Signal Words	5
1.2.1	Personal Injury.....	5
1.2.2	Property Damage.....	5
1.2.3	Information.....	5
1.3	Intended Use	6
1.4	Inappropriate Use.....	6
1.5	Requirements on Operating and Service Personnel	6
1.6	Safety Instructions for Installation and Initial Operation	6
1.7	Safety Instructions for Operation.....	7
1.8	Safety Instructions for Servicing.....	9
1.9	Safety Instructions for Handling Hydraulic Fluid.....	9
1.10	What to Do in the Event of Defects or Malfunctions	9
1.11	What to Do in the Event of an Accident	10
1.12	Safety Features	11
2	Description	12
2.1	General Information	12
2.2	Specifications.....	12
2.3	Sample Nameplate.....	13
3	Transport and Storage	13
4	Installation and Initial Operation	13
5	Operation	14
5.1	Main Switch	14
5.2	Remote Control (Option).....	14
5.3	Controls and Indicators	15
5.3.1	Small Version	15
5.3.2	Large Version	16
5.4	Arm Restraint	17
5.5	Swapping the Flat Head Supports.....	18
5.6	Automatic Roll-off Protection.....	20
5.7	Using Support Blocks	20
5.7.1	Stacking Two Blocks on Top of Each Other	23
5.8	Lift with Hinged-Lid Frame (Option)	24
5.9	Preparations.....	26

5.10	Raising.....	27
5.11	Lowering.....	27
5.12	Wheel-Free Jack (Optional).....	27
5.12.1	Equalising the Wheel-Free Jack.....	27
5.13	Bleeding the Cylinders.....	28
5.14	Manual Lowering.....	29
5.14.1	Mechanical.....	29
5.14.2	Electrical	30
6	Maintenance	32
6.1	Annual Inspection.....	32
6.2	Maintenance Schedule	32
6.3	Care Instructions	33
6.4	Spare Parts	33
6.5	Checking the Fluid Level.....	34
6.6	Greasing Points.....	34
6.7	Troubleshooting	35
7	Service Lifetime.....	36
8	Dismantling.....	36
9	Disposal.....	36
10	Contents of the Declaration of Conformity.....	36

1 Safety

1.1 Introduction

Thoroughly read this manual before operating the equipment and comply with the instructions. Always display the manual in a conspicuous location.

Personal injury and property damage incurred due to non-compliance with these safety instructions are not covered by the product liability regulations.

1.2 Symbols and Signal Words

1.2.1 Personal Injury



DANGER

indicates an immediate hazard which, if not avoided, will result in death or severe personal injury.



WARNING

indicates a potential hazard which, if not avoided, could result in death or severe personal injury.



CAUTION

indicates a potential hazard which, if not avoided, could result in moderate or minor personal injury.

1.2.2 Property Damage



NOTICE

indicates a potentially harmful situation which, if not avoided, could result in damage to the equipment or surrounding objects.

1.2.3 Information



indicates important information notes.

1.3 Intended Use

- This lift shall be used exclusively for the safe lifting of motor vehicles. Observe the rated load capacity and load distribution.
- The lift shall not be modified without the express written consent of the manufacturer. In case of non-compliance the declaration of conformity becomes void.

1.4 Inappropriate Use



WARNING

Any use other than described is inappropriate, for example:

- Climbing on the lift supports
 - Transporting persons on the lift supports
 - Usage as mobile work platform or for other lifting operations
-

1.5 Requirements on Operating and Service Personnel



WARNING

All persons employed in the operation, maintenance, installation, removal and disposal of the device must

- be at least 18 years old,
 - be mentally and physically suited for these activities,
 - be demonstrably trained and instructed in writing,
 - have read and understood the operating instructions, especially the instructions what to do in the event of defects or malfunctions,
 - be on record as having been instructed in safety guidelines,
 - have practical experience in working with vehicle lifts and the hazards inherent in such equipment.
-

1.6 Safety Instructions for Installation and Initial Operation



WARNING

- The lift shall be installed and commissioned by authorised service personnel only.
 - Use personal protective equipment.
 - All safety features must be checked for proper function at commissioning.
 - The control desk (if present) shall not be installed in the danger zone of the lift.
 - The standard lift version shall not be installed and commissioned in hazardous
-

locations, outdoors, in moist rooms (e.g. car wash) or outside a temperature range of 5...40 °C (41...104 °F).

1.7 Safety Instructions for Operation



WARNING

- Observe the detailed operating instructions.
 - Observe all accident prevention regulations.
 - Use personal protective equipment.
 - The standard lift version shall not be operated in hazardous locations, outdoors, in moist rooms (e.g. car wash) or outside a temperature range of 5...40 °C (41...104 °F).
 - To ensure safe operation, check the functionality of all safety devices before using the lift.
 - The control desk (if present) must be positioned in such a way that there is an unobstructed view to the complete working area and the emergency stop can be accessed at all times.
 - All structural parts of the equipment must be visually checked at regular intervals.
 - Supply of suitable illuminating devices is the owner's/operator's responsibility.
 - Do not allow anyone to stay in the danger zone when driving on or off the lift.
 - Lifts with cylinder and runways: when lifting vehicles with a short wheelbase, make sure that one axle is in front of the lifting cylinder, the other behind it.
 - Lifts with wheel-free jack: before driving on or off the lift or wheel-free jack, make sure the jack is in bottom position.
 - If the operator is unable to see all parts of the danger zone, a trained second person must monitor such areas.
 - Center the vehicle on the lift when it is in fully lowered position.
 - After positioning the vehicle on the lift secure it against roll-off.
 - Lifts with runways: make sure the vehicle tyres do not contact the roll-off protection when raising or lowering the lift.
 - Lifts with runways: modifications (such as usage of extensions) are permissible only under the condition that the functionality of the roll-off protection is maintained (protective position of ≥ 0.1 m above the runways).
 - The load rating on the identification plate must not be exceeded.
 - Keep the path of movement free of obstructions.
 - Only use the vehicle manufacturer's recommended lift points.
 - Only use lifting supports approved by the vehicle manufacturer.
 - The vehicle must be lifted as a whole. usage of external hoisting and support
-

devices in combination with the lift must be approved by the manufacturer.

- Do not use the lift for transporting persons.
 - Lifts with support arms or wheel-free jack: when raising the lift, all support points at the vehicle body must be engaged at the same time.
 - Lifts with support arms or swing arm jack: use one additional extender or one support block only for each support point.
 - Lifts with support arms or swing arm jack: check arm restraints for secure engagement as soon as support arms contact vehicle lift points.
 - Lifts with wheel-free jack: secure engagement of the vehicle must be ensured by using appropriate means (e.g. lashing straps).
 - After raising the vehicle briefly, stop and check the lift supports for secure contact.
 - Make sure the vehicle doors are closed during raising and lowering cycles.
 - Make sure the parking brake is applied during raising and lowering cycles.
 - Closely watch lift and vehicle during raising and lowering cycles.
 - Do not allow anyone to stay in lift area during raising and lowering cycles.
 - Lifts with support arms or wheel-free jack: after setting down the vehicle, check the lift supports for secure contact before raising the vehicle again.
 - Axle lift (if present): observe the installation instructions. Use both hands when moving the axle lift. The axle lift must be in park position during raising and lowering cycles.
 - Axle lift (if present): the vehicle must be additionally secured against rolling off while one axle is in a raised position.
 - Do not allow anyone to climb up the lift or the raised vehicle.
 - Before leaving the lift, fully lower the vehicle or secure it against accidental lowering.
 - Keep lift and vehicle free of tools and parts.
 - Keep the lift and lift area clean. Risk of slippage on oily floors!
 - The main switch serves as emergency stop switch. In case of emergency turn it to "0".
 - Protect the lift against unauthorized usage by padlocking the main switch.
 - Protect all parts of the electrical equipment from humidity.
 - Use caution with operating vehicle engines. Danger of poisoning!
 - When removing heavy vehicle components, the centre of gravity can change. In such circumstances appropriate action must be taken as required.
 - Residual risk: Tripping over runways of surface mounted lifts, tripping over tools.
-

1.8 Safety Instructions for Servicing



WARNING

- Use personal protective equipment.
 - Service work must be done by authorized service technicians.
 - Turn off and padlock the main switch before doing any repair, maintenance or setup work.
 - The system must be unpressurized during maintenance work.
 - Work on pulse generators or proximity switches must be done by authorized service technicians.
 - Work on the electrical equipment must be done by service technicians or qualified electricians.
 - Ensure that ecologically harmful substances are disposed of in accordance with the appropriate regulations.
 - Do not use high pressure or steam jet cleaners. Do not use caustic cleaning agents.
 - The lift's safety devices must be set by authorized service technicians.
 - Do not replace or override the safety devices.
-

1.9 Safety Instructions for Handling Hydraulic Fluid



CAUTION

- Neutralize hydraulic fluid spills with binder.
 - Remove contaminated clothing immediately.
 - Inhalation: If symptoms persist, seek medical treatment.
 - Skin contact: Wash skin immediately with soap and water. If skin irritation persists, seek immediate medical advice.
 - Eye contact: Rinse thoroughly with water and seek medical advice.
 - Ingestion: Do not induce vomiting. Seek immediate medical attention.
-

1.10 What to Do in the Event of Defects or Malfunctions



WARNING

- In case of defects or malfunctions such as uncontrolled lift movement or deformation of the superstructure, support or lower the lift immediately.
 - Turn off the main switch and secure it against unauthorized usage. Contact service.
-

1.11 What to Do in the Event of an Accident

- The injured person is to be removed from the danger area. Find out where dressing and bandages are kept. Seek first-aid.
- Provide first-aid (stop bleeding, immobilise injured limbs), report the accident and seal off the accident site.
- Immediately report any accident to your supervisor. Make sure a record is kept of every occasion first-aid is provided, e.g. in an accident book.
- Remain calm and answer any questions that may arise.

1.12 Safety Features



WARNING

Modifications to the safety features by the owner/operator are prohibited!

Main Switch

The main switch serves to switch the lift on and off and as emergency stop. In switch position "0" the system is completely disconnected from the power supply. The main switch can be padlocked to prevent unauthorized usage.

Dead Man's Type Control

Any control is only functional as long as it is being pushed.

Equalising Bar

The cross bar ensures level lifting height and speed for both cylinders.

Roll-off Protection

The roll-off protection bars at the end of each runway prevent the vehicle from rolling off the lift when in a raised position.

Pressure Relief Valve

The working pressure is limited by the pressure relief valve.

Pinch Point Protection

When fully lowering the lift, the lift automatically stops shortly before reaching bottom position. To lower the lift completely, the "Lower" button must be released and pushed again. Lift travel to the lower limit stop is accompanied by an audible signal.

2 Description

2.1 General Information

This lift model is equipped with a swing arm, flat head or runway type super-structure supported by two stationary, internally arranged hydraulic cylinders. These are connected by a cross bar to ensure synchronized movement. The lift is operated via a dead man's type control using pushbuttons.

2.2 Specifications

Load capacity	3500 kg	4000 kg	5000 kg	5500 kg	6500 kg
Piston centers	1350 mm 2300 mm 2500 mm	1350 mm 2300 mm	1350 mm 1567 mm 2300 mm	1350 mm 2300 mm	2700 mm
Full travel	1900 mm				
Installation depth	2400 mm				
Installation depth of hinged-lid frame	2536 mm				
Cylinder dimensions	180 x 180 mm				
Raising time	approx. 27 s		approx. 38 s		
Lowering time (load-dependent)	min. 25 s				
Motor power	3 kW				
Supply voltage	3~ 400 V; 50 Hz				
Fuse protection	16 A slow breaker				

2.3 Sample Nameplate



3 Transport and Storage



NOTICE

Check package to ensure it is complete, in accordance with the order confirmation. Report any transport damage to the carrier immediately.

During loading, unloading and transport always use suitable lifting equipment, material handling equipment (e.g. cranes, forklifts, etc.) and the right load handling attachments and slings. Always ensure that the parts to be transported are suspended or loaded properly so that they cannot fall, taking into account size, weight and the centre of gravity.

Store the packages in a covered area, protected from direct sunlight, at a low humidity and with temperatures between 0...+40 °C (32...104 °F). Do not stack packages.

When unpacking, take care to avoid any possibility of injury or damage. Keep at a safe distance when opening the package strapping, do not allow any parts to fall out.

4 Installation and Initial Operation



WARNING

Installation and initial operation of the equipment may be done only by authorized and trained service technicians provided by the manufacturer, licensed dealers or service partners.

5 Operation

5.1 Main Switch



DANGER

The main switch is used as emergency switch. In case of emergency immediately turn it to position 0!

Main switch in position 0

→ Lift is disconnected from power supply

Main switch in position 1

→ Lift is ready for operation



5.2 Remote Control (Option)

Controls and Indicators

Same assignment as with stationary control unit (large version).

Emergency Stop

Emergency stop is enabled by pushing the red mushroom button.



5.3 Controls and Indicators

5.3.1 Small Version

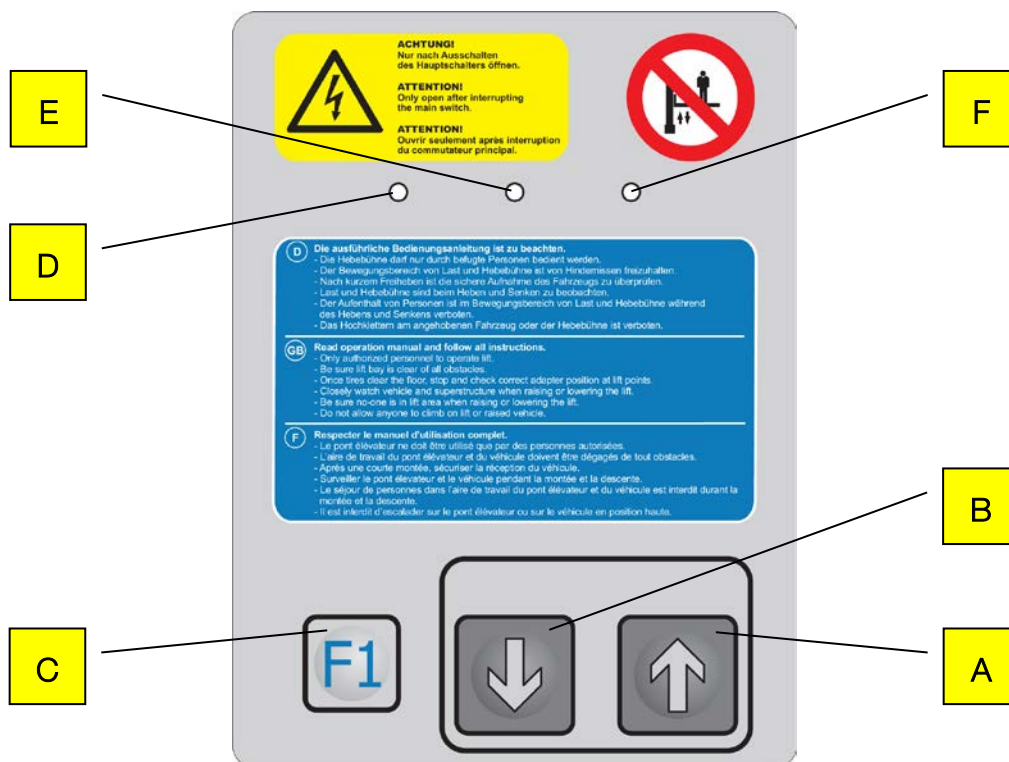

	Function	Short Form
A	Raise lift	LIFT UP
B	Lower lift	LIFT DOWN
C	(w/o function)	F1
D	LED red (Malfunction or Error code); see LED Code below	
E	LED yellow (Warning or Error code); see LED Code below	
F	LED green (Ready for operation); see LED Code below	

LED Code			Status / Notice / Error
RED	YELLOW	GREEN	
---	---	Lighting	Ready for operation
Lighting	Flashing 3x	---	Inputs (Key contact)
Lighting	Flashing 6x	---	Liquid level indicator

LED Code			Status / Notice / Error
RED	YELLOW	GREEN	
Lighting	Flashing 7x	---	Motor temperature
Lighting	Flashing 8x	---	Switch monitoring "CE Stop"

5.3.2 Large Version

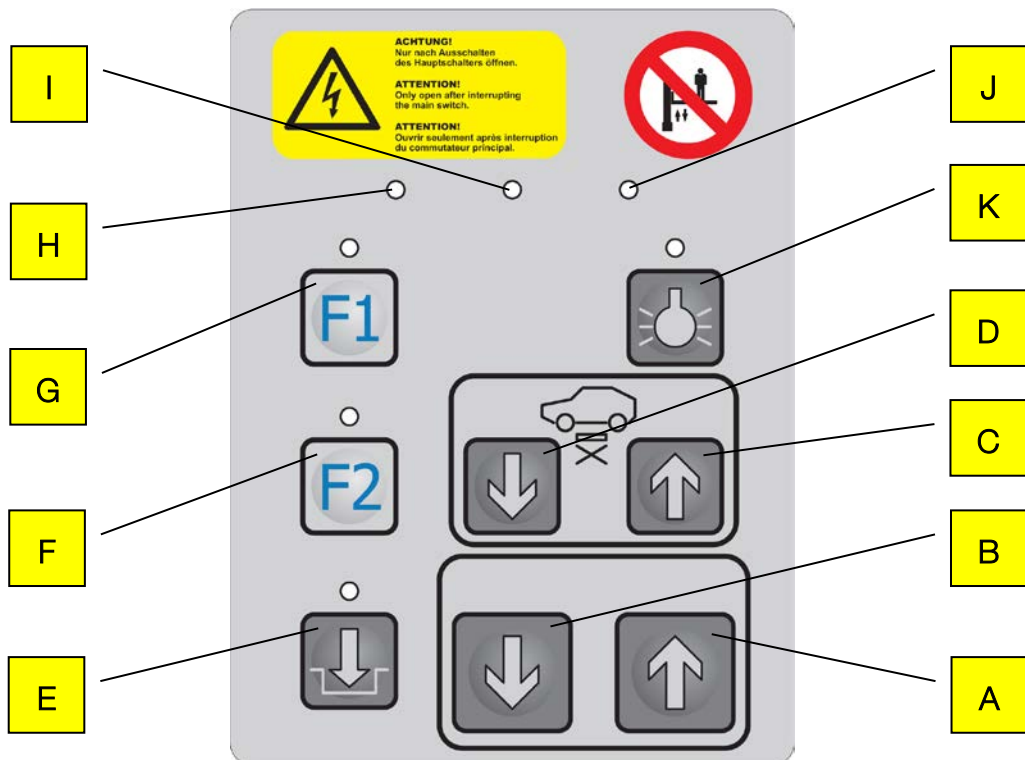

	Function	Short Form
A	Raise lift	LIFT UP
B	Lower lift	LIFT DOWN
C	Raise wheel-free jack	WFJ UP
D	Lower wheel-free jack	WFJ DOWN
E	Floor compensation On/Off <i>On (LED on): Floor compensation is always lowered</i> <i>Off (LED off): Floor compensation is lowered when below CE Stop, raised when above</i>	FLOOR
F	Multifunctional key 2	F2
G	Multifunctional key 1 (not assigned)	F1

	Function	Short Form
H	LED red (Malfunction or Error code); see LED Code below	
I	LED yellow (Warning or Error code); see LED Code below	
J	LED green (Ready for operation); see LED Code below	
K	Illumination On/Off <i>On (LED on): Illumination is on when above CE Stop and is off when below</i> <i>Off (LED off): Illumination is always off</i>	

LED Code			Status / Notice / Error
RED	YELLOW	GREEN	
---	---	Lighting	Ready for operation
Lighting	Flashing 2x	---	Inputs (Key contact) internal
Lighting	Flashing 3x	---	Inputs (Key contact) external
---	Lighting	Lighting	Axle lift not in position
---	Flashing 4x	Lighting	Axle lift not in position, below CE Stop (pinch protection)
---	Flashing 5x	Lighting	Ceiling light barrier
---	Flashing 6x	Lighting	Liquid level indicator
---	Flashing 7x	---	Emergency stop switch (Remote control)
Lighting	Flashing 8x	---	Motor temperature
Lighting	Flashing 9x	---	Switch monitoring "Lift fully raised"
Lighting	Flashing 10x	---	Switch monitoring "CE Stop"
---	---	Flashing	Service interval expired

5.4 Arm Restraint

When the lift is in bottom position, the arm restraint is released and the swing arms are free to swing.

When the lift is in a raised position, the locking mechanism is engaged and the swing arms cannot be moved.

5.5 Swapping the Flat Head Supports

The flat head supports can be swapped as required between the right- and left-hand support sides.

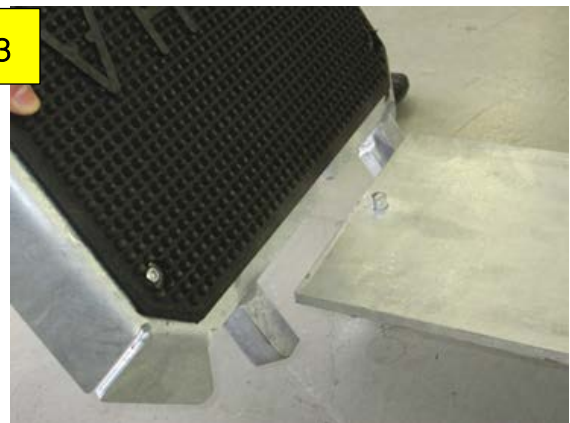

- 1 Slightly raise the lift.
- 2 Tilt the support plate upwards...
- 3 ...detach it from the retaining pin...
- 4 ...and remove it completely.
- 5 Replace with new support plate.



Do not open any screws when changing the flat head supports!

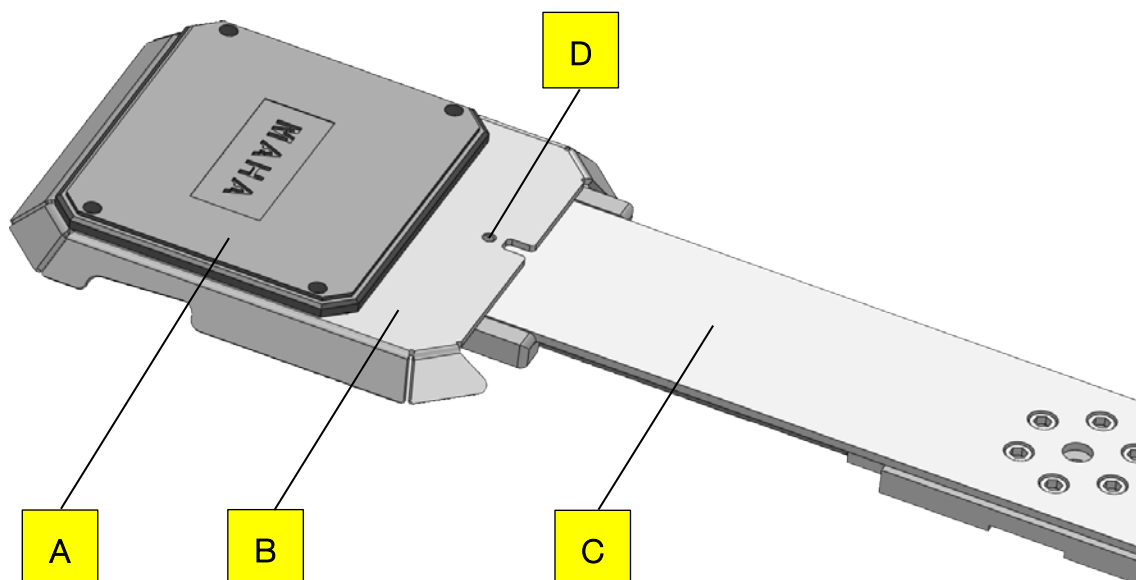

A Rubber pad

B Flat head support

C Flat head beam

D Retaining pin



CAUTION

- Do not exceed the maximum extension range of the flat head support.
- Before positioning the vehicle on the lift, make sure the flat head support is locked and the retaining pin (D) has snapped into place.

Flat head support not locked



Maximum extension range exceeded



5.6 Automatic Roll-off Protection

After positioning the vehicle on the lift secure it against roll-off. Make sure the vehicle tyres do not contact the roll-off protection when raising or lowering the lift (see Fig.).



WARNING

- After a tyre has collided with the automatic roll-off protection, immediately check it for proper function.
- If the functionality of the roll-off protection cannot be ensured or if it is impaired by the contacting vehicle tyre, the lift must not be lowered into bottom position.



5.7 Using Support Blocks

- 1 The support blocks are approved for usage on lifts with a rated load capacity of 3,500 kgs.
- 2 Always use four original MAHA support blocks of identical size and shape.
- 3 Do not use support blocks with cracks, broken-off pieces or other damage.
- 4 Check that all support blocks and rubber pads are free of oil, grease, dirt or debris.
- 5 Place the support blocks under the vehicle manufacturer's recommended lift points.
- 6 Note correct positioning of the support blocks.
- 7 Raise the vehicle until the tyres clear the floor. Stop and recheck the lift supports for secure contact with the vehicle body.

The support block must be placed fully on the surface without extending beyond the edges.

A Extension

C Support block

B Support surface; available are:

- Granulate coating
- Granulate foil
- Rubber plate

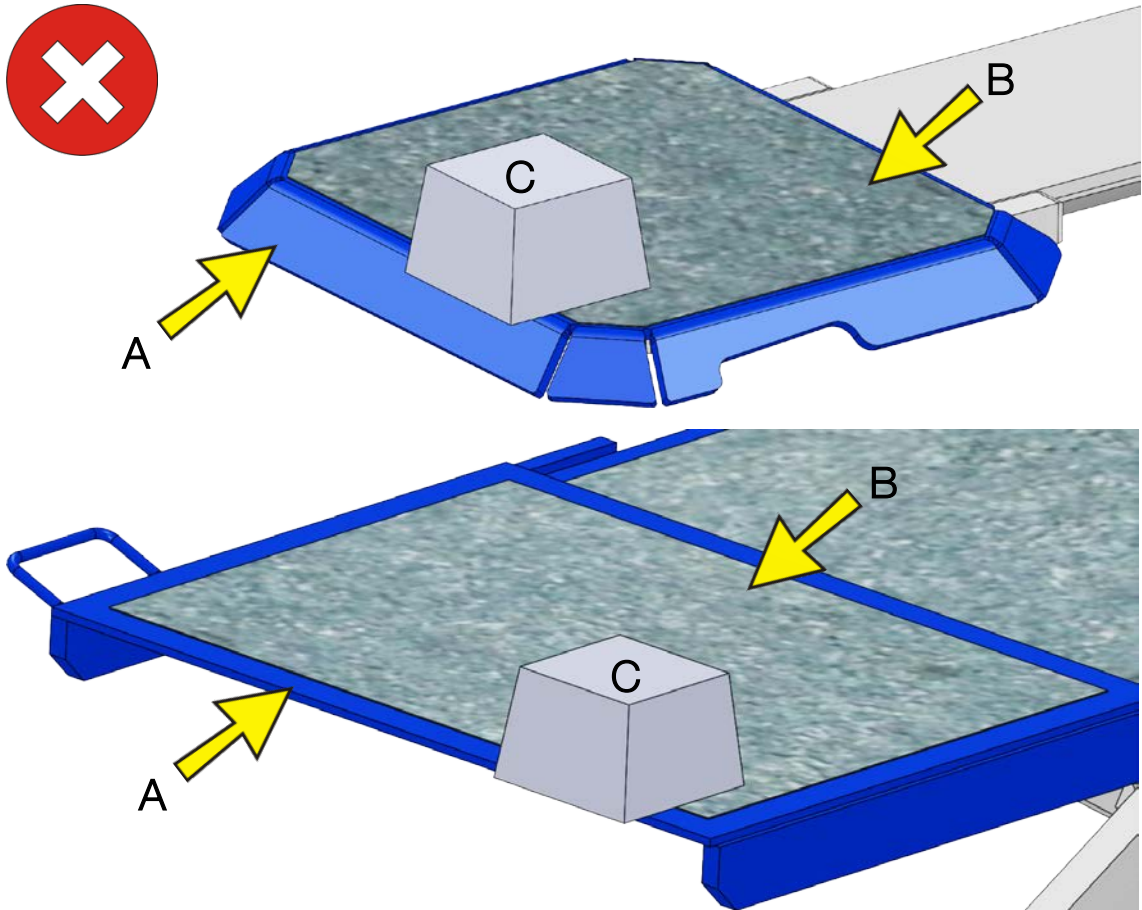

Diagonal positioning is permissible only with granulate coated surfaces (a). If knobby pads are used, these must mesh with the support blocks (b).

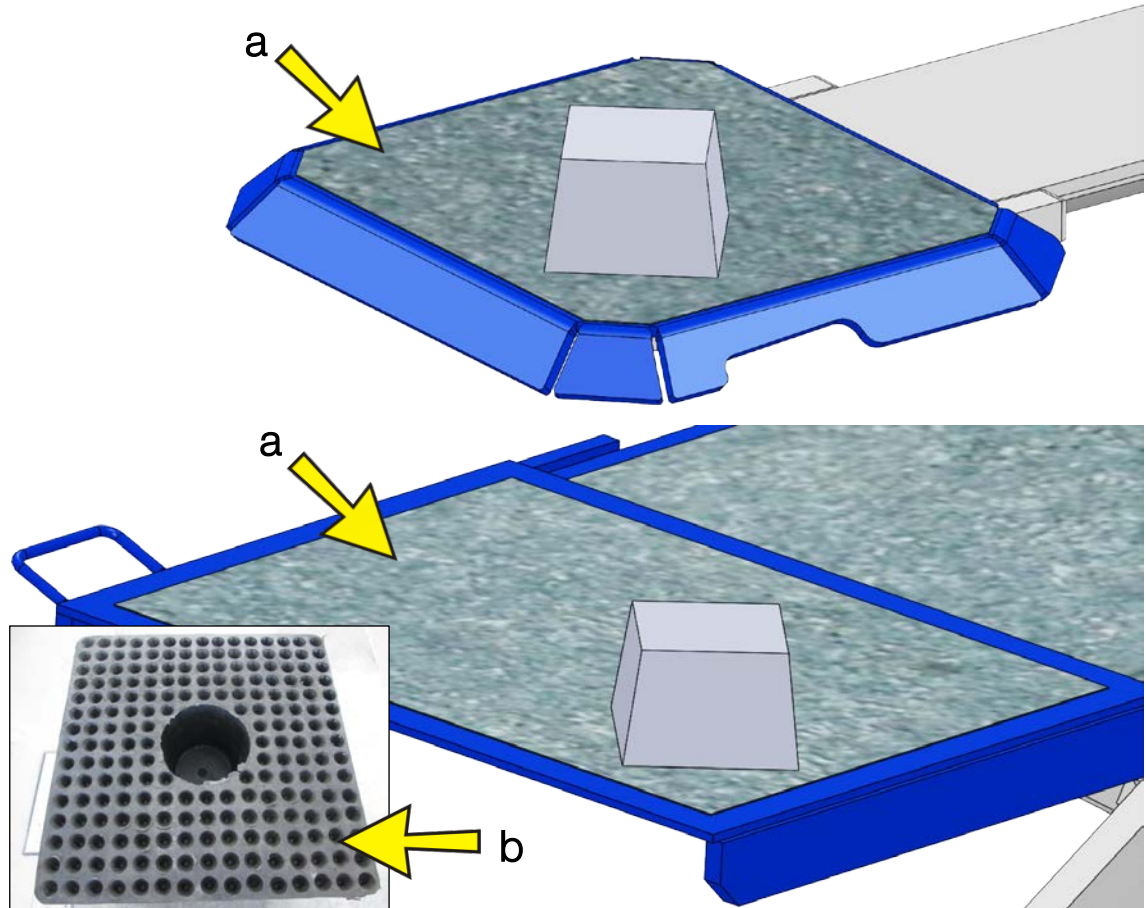

5.7.1 Stacking Two Blocks on Top of Each Other

Only the "DUO" hard rubber blocks (VZ 975074) and the ductile plastic blocks (VZ 970045) may be stacked on top of each other, but not more than two blocks per lifting point.

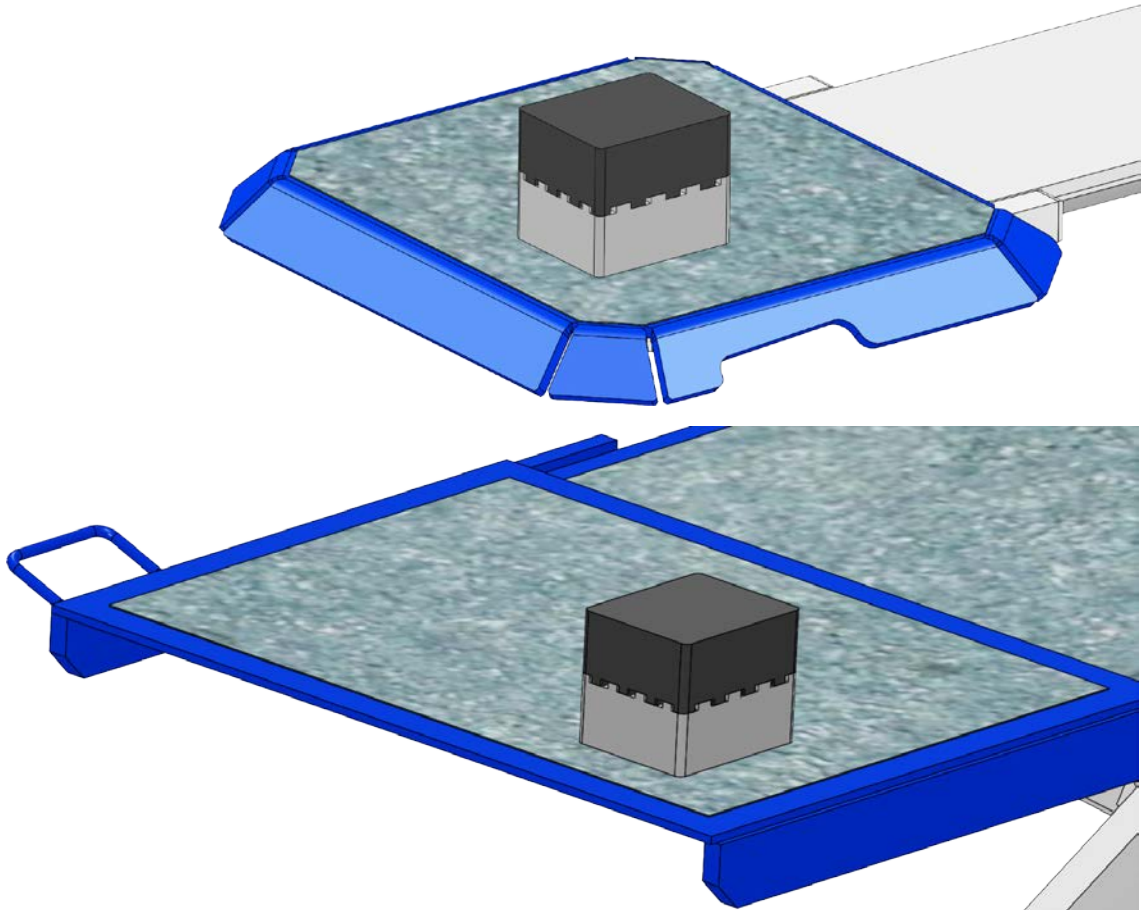

5.8 Lift with Hinged-Lid Frame (Option)



1 Lift with hinged-lid frame, fully flush with the floor.

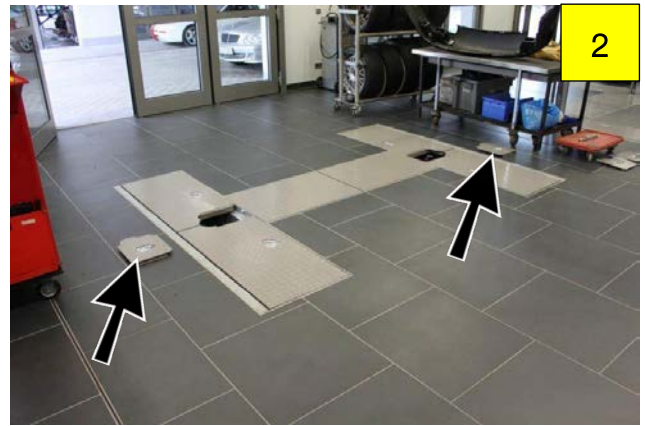

2 Remove both cylinder covers and keep them safe.

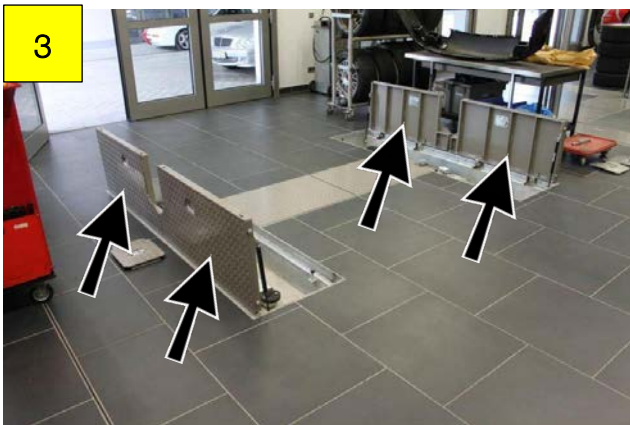

3 Manually open the four hinged lids.



4 Raise the lift until it is above the top edge of the opened lids (lifting height approx. 1 m).

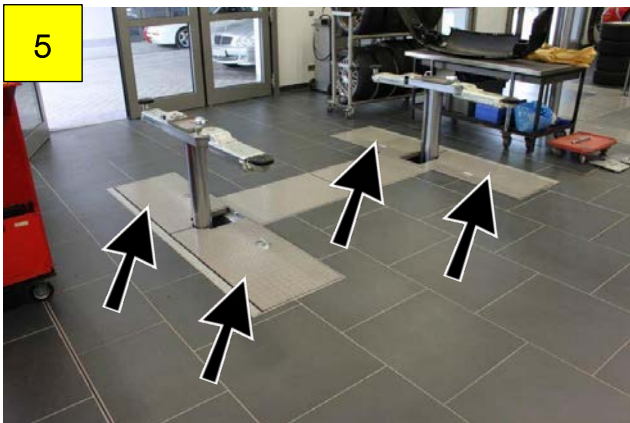

5 Manually close the four hinged lids. Lower the lift to bottom position.

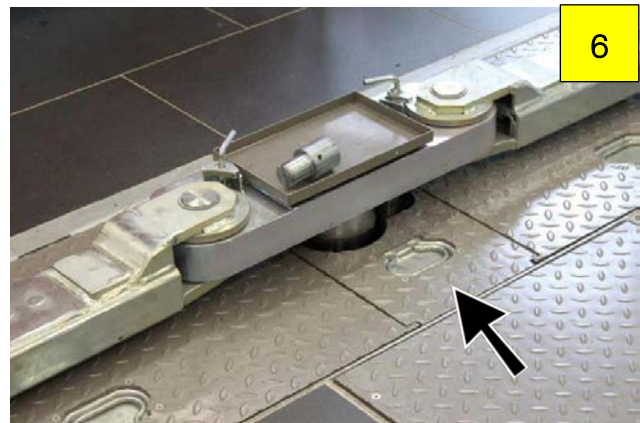

6 Insert both cylinder covers (with recess).



7 The lift is ready for operation, vehicles can be raised.

8 To lower the lift into the hinged-lid frame, proceed in reverse order as described above.

5.9 Preparations

Swing Arm Superstructure

- 1 Fully lower the lift. Swing arms sideways to clear the approach path.
- 2 Slowly center the vehicle between the cylinders.
- 3 Apply the parking brake to prevent the vehicle from rolling off.
- 4 Position all four adapters under vehicle manufacturer's recommended lift points.
- 5 The support discs are height-adjustable. Make sure they evenly engage the vehicle frame.
- 6 Leave the vehicle and the danger zone around the lift.

Flat Head Superstructure

- 1 Fully lower the lift. Slowly drive the vehicle over the supports so that these are in center between the axles.
- 2 Apply the parking brake and use chocks to prevent the vehicle from rolling off.
- 3 Lift the extensions at their front edges and position them under the vehicle manufacturer's recommended lift points.
IMPORTANT: Make sure the extensions snap into place!
- 4 Position spacer blocks under the lift points.
- 5 Leave the vehicle and the danger zone around the lift.

Runway Superstructure

- 1 Fully lower the lift. Slowly center the vehicle on the runways.
- 2 Apply the parking brake and use chocks to prevent the vehicle from rolling off.
- 3 Leave the vehicle and the danger zone around the lift.

5.10 Raising

- 1 To raise the lift, push and hold the RAISE LIFT button, until the desired lifting height is reached.
- The lift movement stops when the button is released or the upper end stop is reached.

5.11 Lowering

- 1 To lower the lift, push and hold the LIFT DOWN button until the desired height is reached.
- The lift movement stops when the button is released, the CE safety stop is reached or the lower end stop is reached.
- 2 To lower the lift to bottom position after reaching the CE safety stop, release the LIFT DOWN button and push it again.

5.12 Wheel-Free Jack (Optional)

- Make sure the vehicle is centered above the wheel-free jack.
- 1 If necessary, place plastic spacer blocks under the vehicle lifting points.
 - 2 Use the WFJ UP button to raise the lift.
 - 3 Raise vehicle briefly and check adapters for secure contact at vehicle manufacturer's recommended lift points.
 - 4 Then raise vehicle to desired height.
 - 5 Use the WFJ DOWN button to lower the lift.

5.12.1 Equalising the Wheel-Free Jack

To actuate the Slave cylinder, push the <F2> button, then the <WFJ UP> or <WFJ DOWN> button.



CAUTION

Equalise the wheel-free jack only without vehicle and in a fully lowered position.

5.13 Bleeding the Cylinders



WARNING

Do not bleed the hydraulic system under load.

The bleeder screws (A) are located between the attachment screws of the superstructure and can be accessed through a drill hole.



If the lift is equipped with runways and wheel-free jack, the WFJ must be fully raised to make the bleeder screws accessible.

- 1 Raise the lift about half way up.
- 2 Remove the sealing plugs and open the bleeder screws (A) on both cylinders 1 turn max.
- 3 When fluid comes out free from air, close the screws and torque to 50 Nm.
- 4 Insert the sealing plugs.
- 5 Lower lift to bottom position and check fluid level of reservoir, top up as required.

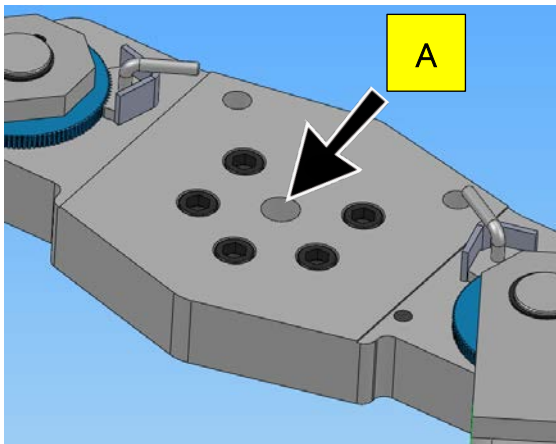

5.14 Manual Lowering



WARNING

Authorised personnel only! Do not restart the lift before the error has been remedied.

5.14.1 Mechanical

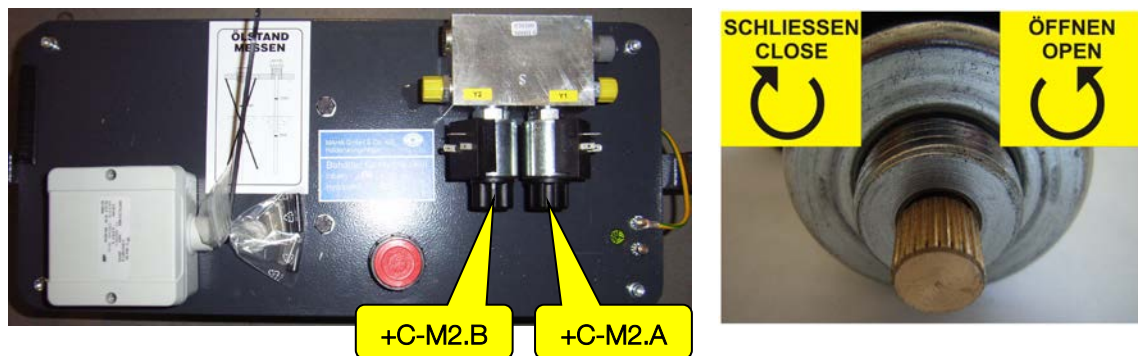

- 1 Remove the centre cover.
- 2 Open valve **+C-M2.A**.
→ One side is lowered by approx. 5 cm.
- 3 Open valve **+C-M2.B**. Leave the movement range of the lift and vehicle immediately!
→ The lift is lowered.
- 4 When the lift has been lowered completely, close **+C-M2.A** and **+C-M2.B**.

5.14.2 Electrical

- A Plug block, 4-pin, or manual lowering
- B Standard plug for normal operation
- C Polyester cord for securing the standard plug
- D In case of power failure, unplug the standard plug and plug in the emergency down cable plug.
- E The other end of the cable is clamped with the alligator clamps to two car batteries (12 V) connected in series.
- F The lift can be lowered via the control, the lifting floor and wheel-free jack are also lowered. Any existing measuring systems remain active.

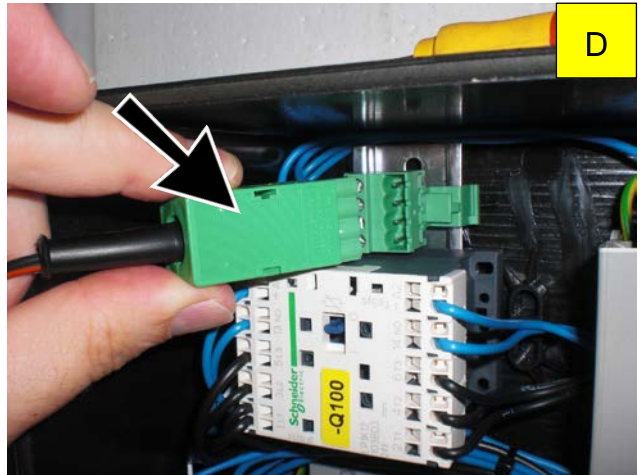
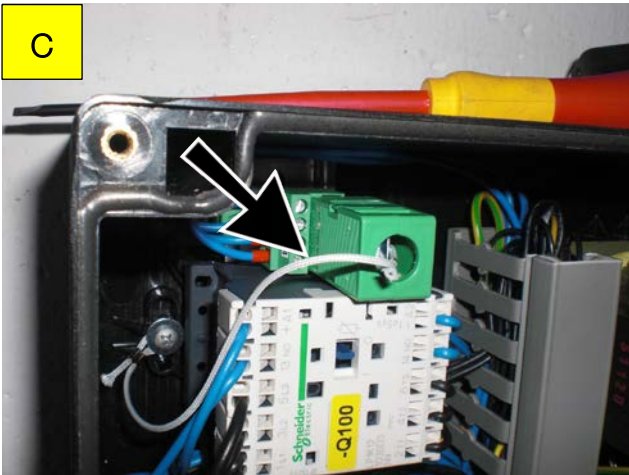
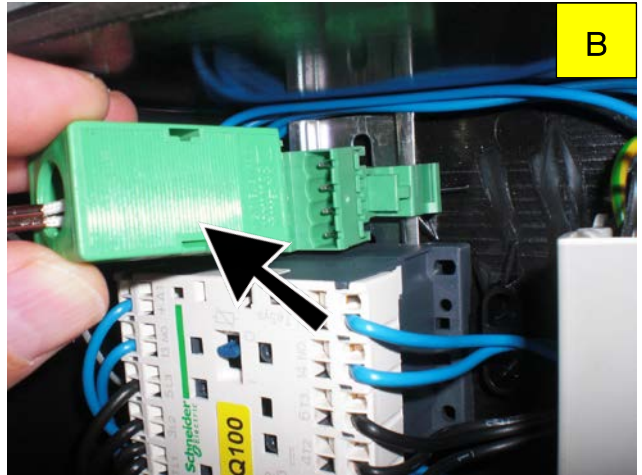
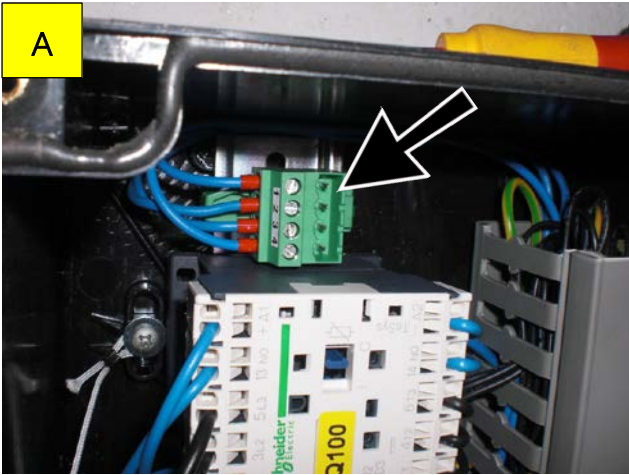

6 Maintenance



DANGER

Risk of death or severe personal injury by electric shock



Before doing any maintenance work, turn off the main switch and protect it against tampering.

6.1 Annual Inspection



- The maintenance interval prescribed by the manufacturer is **12 (twelve) months**. This maintenance interval refers to normal workshop usage. If the equipment is used more frequently or under severe operating conditions (e.g. outdoors), the interval must be reduced accordingly.



- Maintenance work shall be done only by authorized and trained service technicians provided by the manufacturer, licensed dealers or service partners.
- In case of non-compliance the manufacturer's warranty becomes void.

6.2 Maintenance Schedule

Interval	Maintenance items	Procedure
3 months	Hydraulic system	Check fluid level, top up if necessary.
		Check hydraulic system for leakage.
		Check power unit for unusual noise during operation. Check fastening screws for tight fit.
	Support discs	Check threads for smooth running.
	Flat head supports	Check extensions for smooth running, grease as required.
6 months	Hydraulic fluid	Check fluid for contamination and ageing, replace if necessary.
12 months	General inspection	Check all components for damage.
6 years	Pressure hoses	Replace all pressure hoses.

6.3 Care Instructions

- Periodically clean the equipment and treat it with a care product.
- Repair damage to the paintwork immediately to prevent corrosion.
- Do not use caustic cleaning agents or high pressure and steam jet cleaners to avoid equipment damage.
- Only use alkaline cleaning agents when cleaning galvanized surfaces.



Regular care and maintenance is the key condition for functionality and long life expectancy of the equipment!

6.4 Spare Parts

To ensure safe and reliable operation, only use original spare parts supplied by the equipment manufacturer.

6.5 Checking the Fluid Level



- Replace the hydraulic fluid periodically, depending on aging, soiling and water absorption.
- When topping up, use fluid with the same specification only.
- If the lift is operated permanently at an ambient temperature of $< 15\text{ }^{\circ}\text{C}$ ($59\text{ }^{\circ}\text{F}$), use hydraulic fluid with a lower viscosity.
- The pressure hoses should be replaced as required, but after six years at the latest.

- 1 Fully lower the lift and any accessory equipment.
- 2 Remove the center cover.
- 3 Remove the filler screw at the hydraulic power unit.
- 4 When checking the fluid level using the dipstick, do not screw in the filler screw. The fluid level should be between the top and bottom level marks.
- 5 Refill fluid with HLPD 22 / HLP 22 (biodegradable) specification. Capacity is indicated on the reservoir.
- 6 Completely screw in the filler screw.

6.6 Greasing Points

- Lightly oil the entire length of the ram and gear rack every six months or as required (e.g. in the event of noise).
- Inspect the support arm extensions every six months for smooth operation and lubricate if necessary.
- Inspect the support plate threads every six months for smooth operation and lubricate if necessary.
- Inspect the rubber pads every six months for wear and replace if necessary.

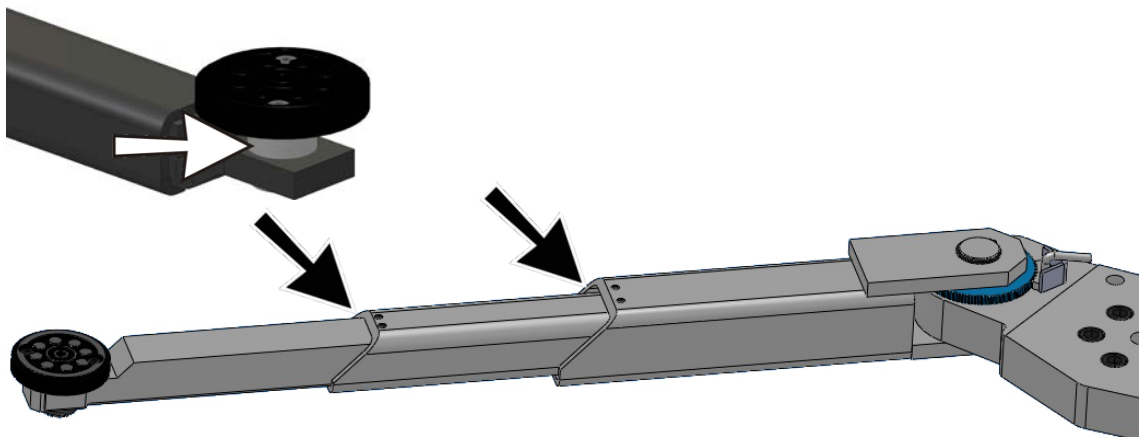

6.7 Troubleshooting

Error	Diagnosis	Remedy
Lighting between runways does not burn.	Fuse F2 defective.	Replace fuse F2 .
Lift cannot be fully raised.	Low fluid level.	Check fluid level, top up as required.
Lift shows jerky movements.	Air in hydraulic system.	Bleed cylinders.
Lift does not respond.	Main switch off.	Turn on main switch.
	Emergency stop switch of remote control actuated.	Unlock emergency stop switch.
	Mains fuse blown.	Replace mains fuse.
	Primary fuse F1 of power supply -T1 blown.	Replace fuse F1.
	Secondary fuses of power supply -T1 blown.	Replace fuses.
	Ceiling light barrier +D-B1 (optional) dirty.	Cautiously clean light barrier.
Motor runs, but pressure build-up insufficient to raise lift.	Pressure relief valve set too low.	Contact service.
	Hydraulic system leaking.	Remove leakage, contact service.
	Low fluid level.	Check fluid level, top up as required.
	Vehicle too heavy.	Reduce load, observe rated load capacity.
Lift with pneumatic floor cover and axle jack cannot be fully lowered.	Axle jack is not in rest position.	Move axle jack to rest position.
	Position switch for axle jack defective or maladjusted.	Contact service.

7 Service Lifetime

In its standard version, this product is designed for 22,000 load cycles based on EN 1493. The maximum period of normal use in relation to the possible product life expectancy shall be evaluated and scheduled by a qualified person during the annual safety inspection.

8 Dismantling

Decommissioning and dismantling of the equipment may be done only by specially authorized and trained personnel provided by the manufacturer, licensed dealers or service partners.

9 Disposal

Pay attention to the product and safety data sheets of the lubricant used. Avoid damage to the environment. Should a disposal of the device be necessary it must be done in adherence with locally applicable legal regulations regarding environmental protection. Remove all materials properly sorted out and bring them to a suitable waste disposal service. Collect operating materials such as grease, oils, coolant, solvent-based cleaning fluids etc. in suitable containers and dispose of in an environmentally protective manner.

Alternatively, you may take the equipment to a specialised waste management plant to ensure that all components and operating liquids are properly disposed of.

10 Contents of the Declaration of Conformity

MAHA Maschinenbau Haldenwang GmbH & Co. KG

herewith declares as a manufacturer its sole responsibility to ensure that the product named hereafter meets the safety and health regulations both in design and construction required by the EC directives stated below.

This declaration becomes void if any change is made to the product that was not discussed and approved by named company beforehand.

Model: ZS SQUARE II / DS

Designation: Two Post Inground Lift; Rated Load Capacity:
3200/3500/4000/5000/5500/6500 kg

Directives: 2006/42/EC; 2014/30/EU

Standards: EN 1493; EN 60204-1